

$\frac{3}{4}$   
4

$\frac{3}{8}$   
1

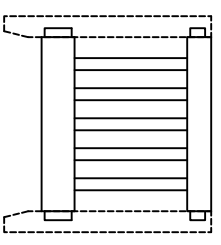

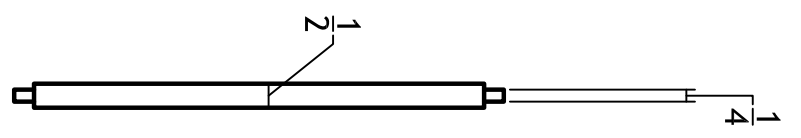
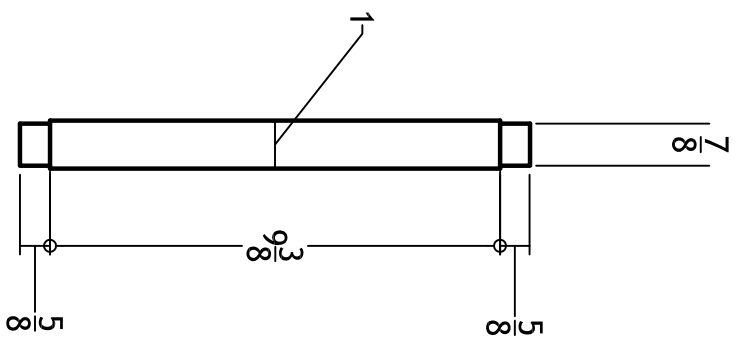
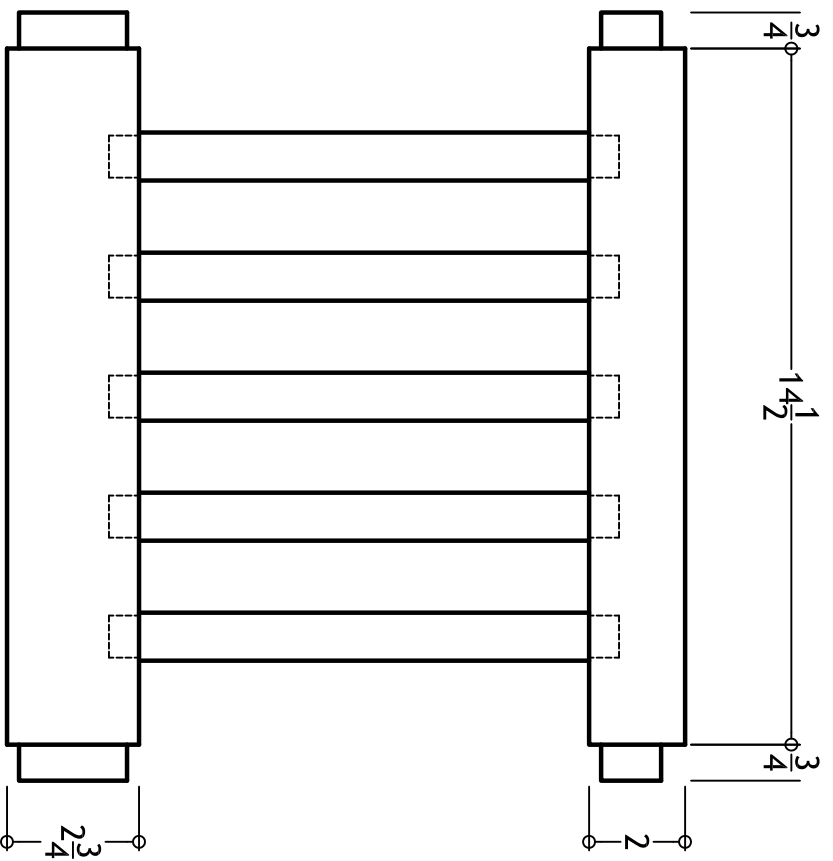
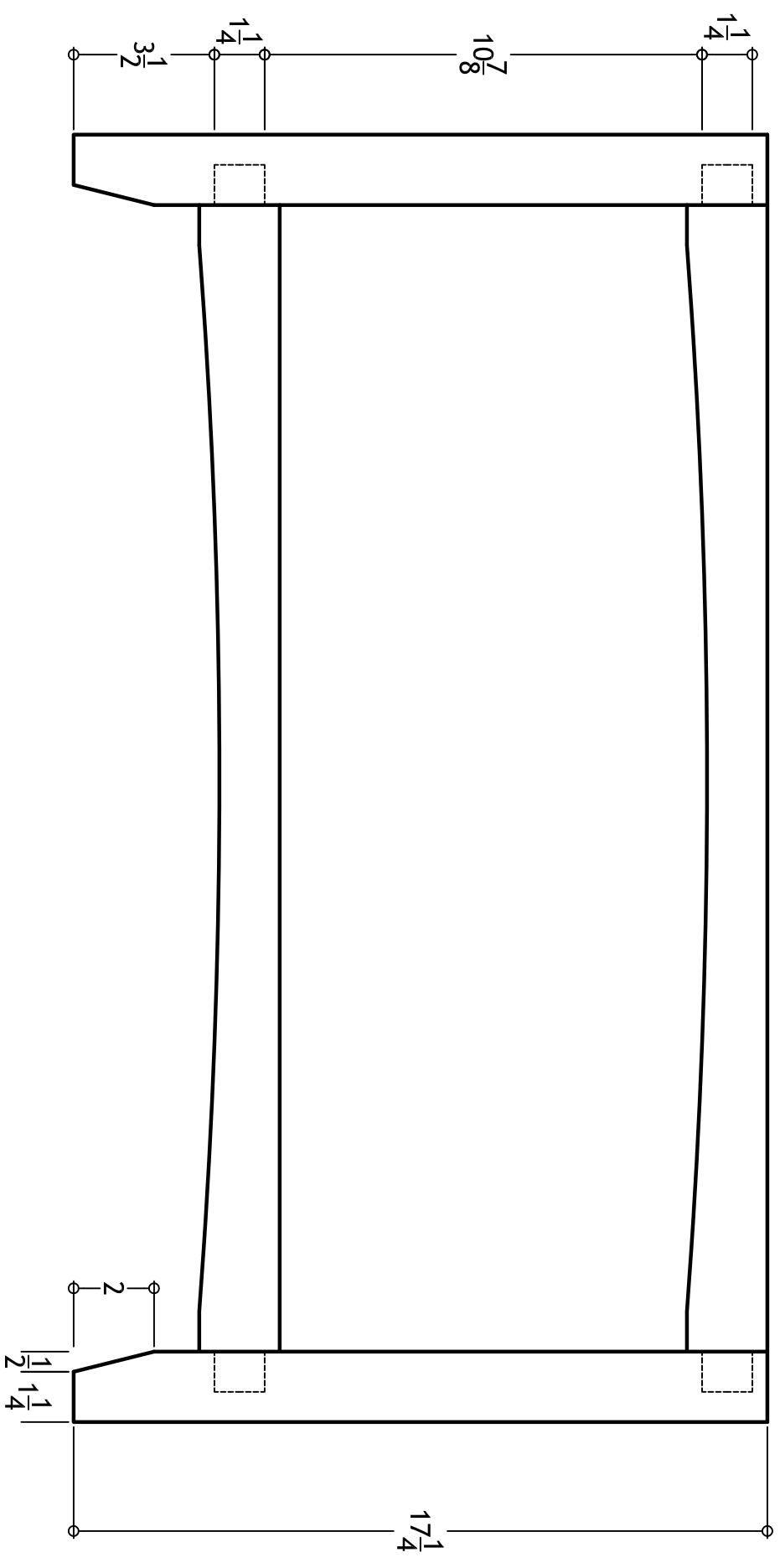
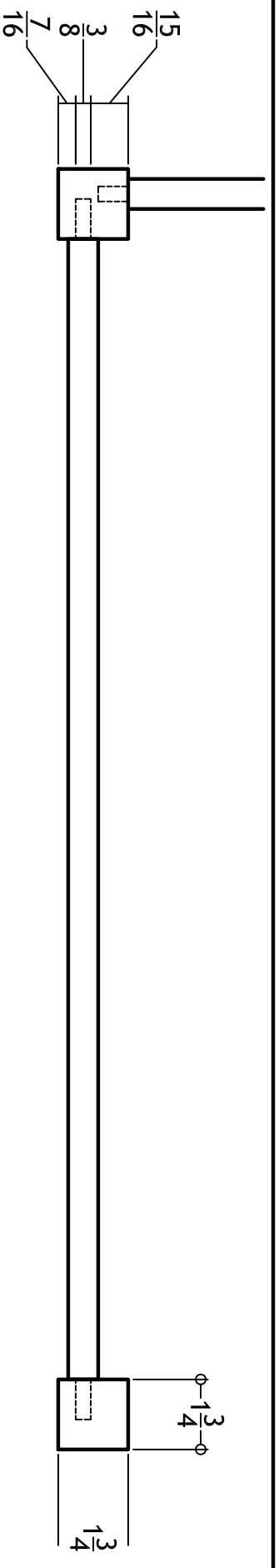

Chess Coffee Table

Ryan T. Walton

Stretcher - Leg Assembly

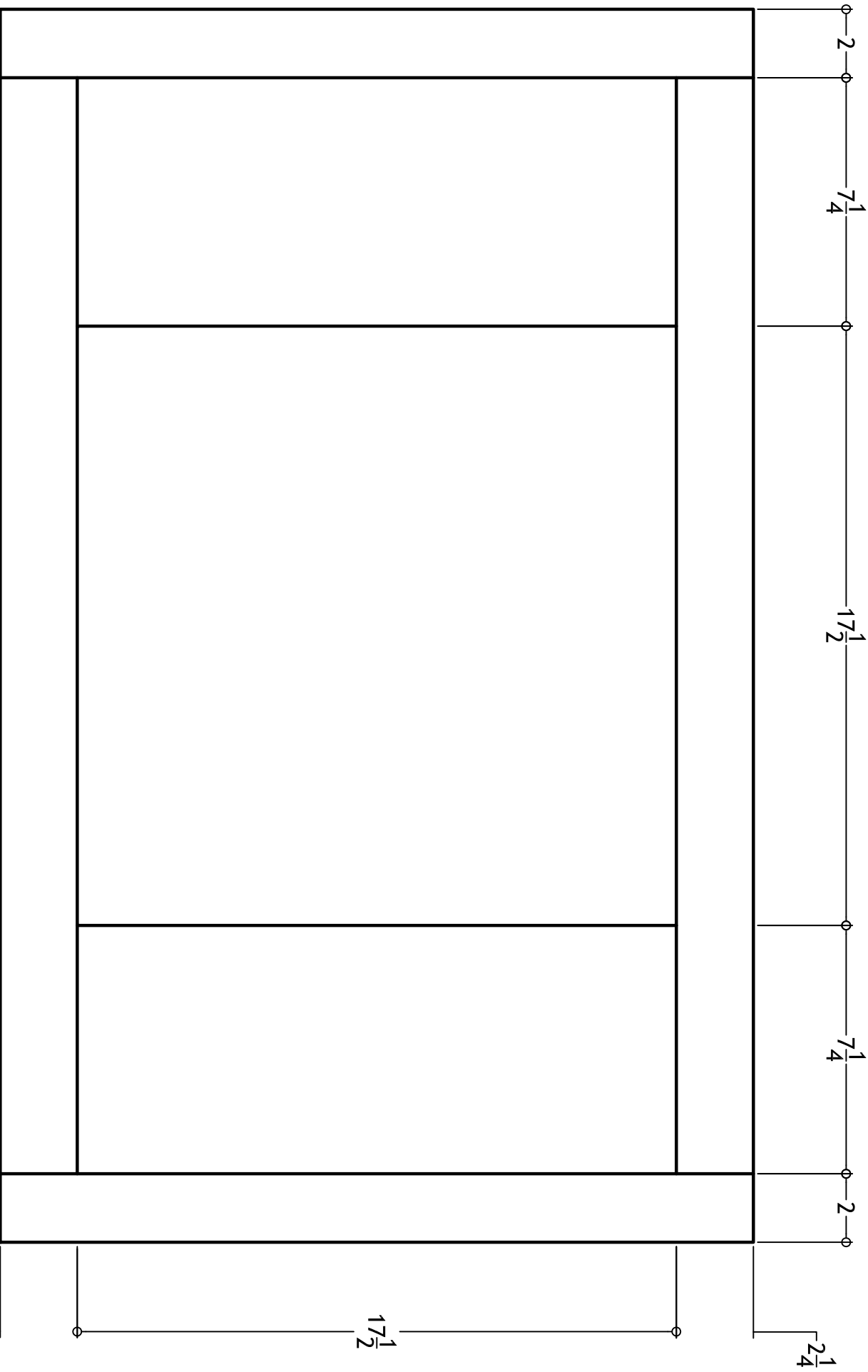

Chess Coffee Table

Ryan T. Walton

Table Top Dimensions

10 -  $\frac{1}{2}$ " x 1" x 10  $\frac{5}{8}$ "

'Spindles'

2 -  $\frac{3}{4}$ " x 2" x 16"

Top Style

2 -  $\frac{3}{4}$ " x 2  $\frac{3}{4}$ " x 16"

Bottom Style

4 -  $\frac{3}{4}$ " x 2" x 30  $\frac{1}{2}$ "

Stretchers

4 - 1  $\frac{3}{4}$ " x 1  $\frac{3}{4}$ " x 17  $\frac{1}{4}$ "

Legs

4 -  $\frac{3}{4}$ " x 3" x 16"

Top - Board Support

1 -  $\frac{3}{4}$ " x 16" x 30"

Shelf

1 -  $\frac{3}{4}$ " x 22" x 36"

Table Top